

SOPHIA 18 SPOTMAX MONOCHROMATIC



SOPHIA SPOT MAX 18 exterior luminaire with high-power OSRAM LED technology. Passive cooling of LEDs with optimised heatsink geometry. No multiple shadows, energy-efficient LEDs with very good colour rendering. The SOPHIA SPOT MAX 18 represents a combination of a balanced design and technology from a Czech manufacturer. The use of quality materials and precision manufacturing offers a professional lighting solution. OSRAM LEDs with a life expectancy of 100,000 hrs give a choice of fantastic illumination. The attractive and compact design provides a truly versatile lighting system. It is ideally suited for use in facade and architectural monument illumination.



PRODUCT SPECIFICATIONS

- INPUT VOLTAGE: 230V AC/50Hz
- POWER CONSUMPTION: 80W (up to 7920lm)
- LIFETIME: > 100 000 hours
- THERMAL PROTECTION: yes
- LED DEVICE: OSRAM high power LEDs
- LED VARIANTS: 2700K, 3000K, 4000K, 5700K and other according requirement
- WEIGHT: 7,5 kg
- OPERATING TEMPERATURE: range -20°C to +40°C
- ENVIRONMENT: for OUTDOOR use, IP65
- MATERIALS: housing-die-cast Aluminium, cover-tempered glass
- CONTROL: ON/OFF or DALI

DIMENSIONAL DRAWINGS

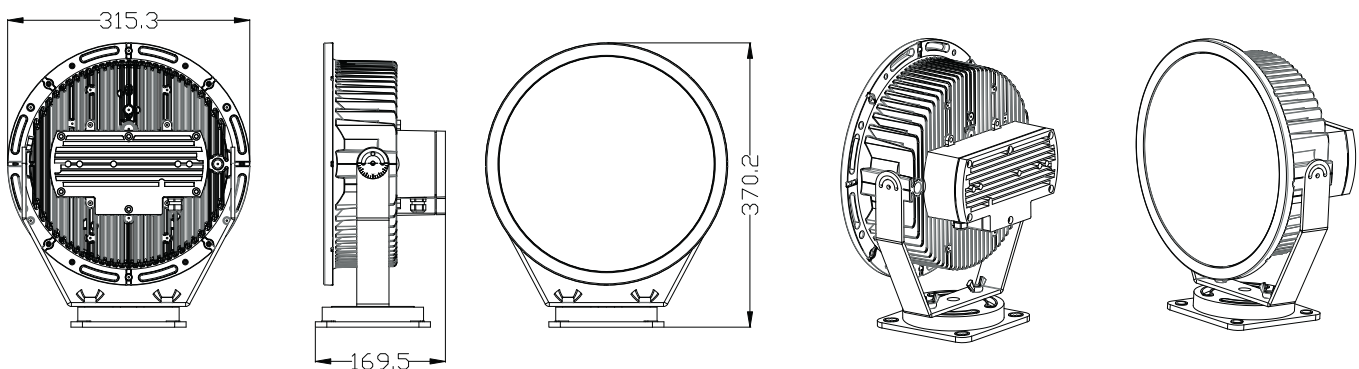

SOPHIA 18 SPOTMAX MONOCHROMATIC

PHOTOMETRICS

■ Variants:

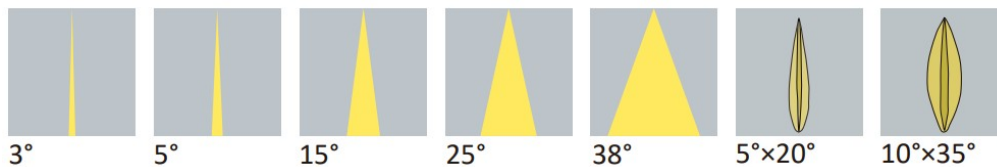

ACCESSORIES

■ See website

CONNECTION

■ See instruction manual