

WARNING:

- Make certain power is OFF from the electrical panel before starting installation or attempting any maintenance. Indoor installation only.
- Do not mix different sizes and styles of fixtures on the same dimmer, not all fixtures will exhibit the same correlated colour temperatures at the same dimming level.

TOOLS REQUIRED:

- Saw
- Measuring Tape
- Electrical Wiring (use type and gauge suitable for application to connect the fixtures)

ASSEMBLY INSTRUCTIONS:

1. Turn power OFF from the electrical panel before starting installation.
2. Locate a suitable position to place the fixture and open a hole in accordance to the cut-hole dimensions (refer to Hole Cut Table* for appropriate size).

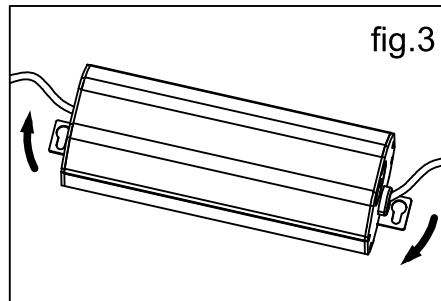
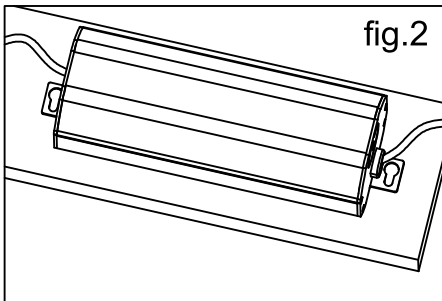

3. Run the electrical supply wire from the switch (power supply) through the mounting hole.
4. Open the hardware box swing cover and remove the appropriate knockout(s).
5. Insert the electrical supply cable through the knockout and secure with a cable connector (sold separately).

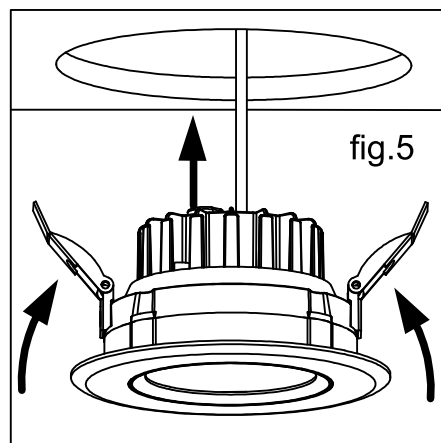
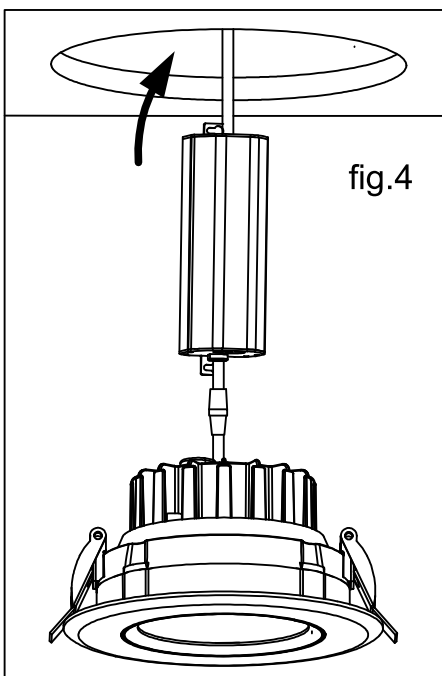

6. Wire the driver inside the hardware box: Connect the blue wire (N), the brown wire (L), and the green/yellow ground wire from the supply cable to the driver terminals. (**Fig. 1**)
7. Place all wiring and connections back in to the box and close the cover.

8. New construction applications: Hardware box shall be firmly secured to studs, joists, or similar fixed structural units. (**Fig. 2**) Remodel applications: Do not require the hardware box to be firmly secured after the mounting plates, studs, joists, or structural units that have been concealed. Snap off the hardware box tabs (**Fig. 3**), then insert into ceiling (**Fig. 4**).

IMPORTANT: Read all instructions before installing fixtures. Retain for future reference.

SAFETY: For your safety, this fixture must be wired in accordance to local electrical codes and ordinances. All work should be done by a qualified electrician.

9. Push spring loaded clips on the fixture upwards and insert fixture base in to the mounting hole. Release the clips and fixture will be pulled flush to the ceiling. (**Fig. 5**)
10. Once assembly is complete, turn on power to confirm fixture is working properly.

HOLE CUT SIZE
ELEKTRA TILT 12 TW + RGBTW
Ø108mm